



INVERURIE
Andersons

FELTON



2. Legs

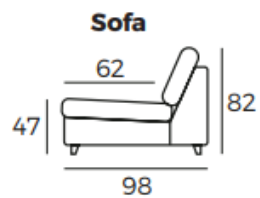

Sofa

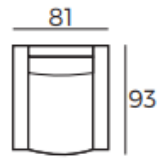

Chair
arm 60 arm

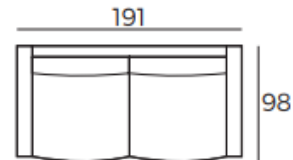

2.5 seater
arm 150 arm

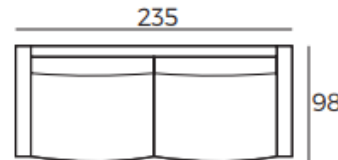

3 seater
arm 195 arm

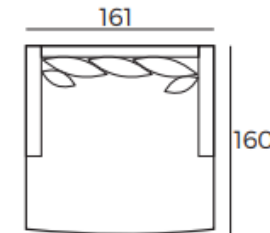

Daybed



Footstool
99x68

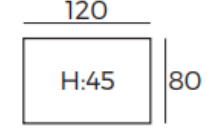

Footstool
120x80

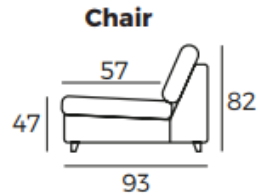

Chair

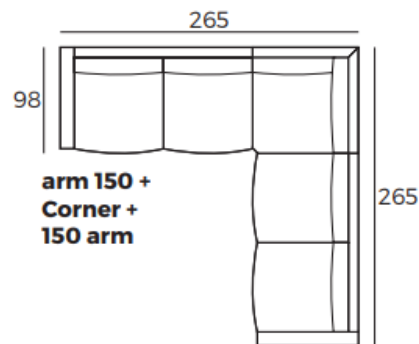

**arm 150 +
Corner +
150 arm**

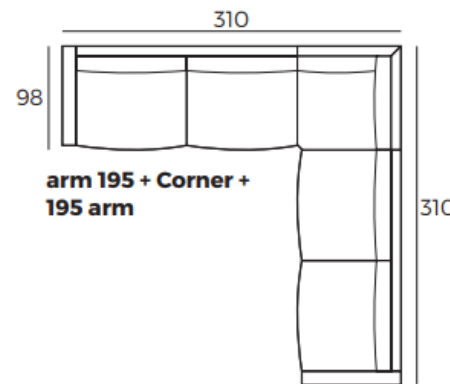

**arm 195 + Corner +
195 arm**

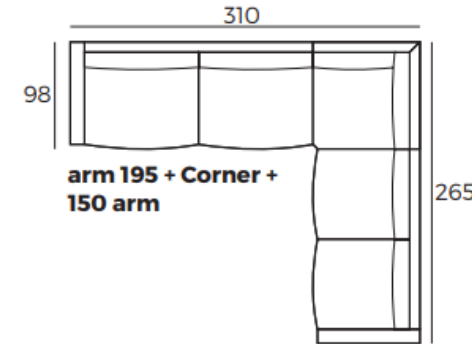

**arm 195 + Corner +
150 arm**

Highclere Business Park, Inverurie, Aberdeenshire AB51 5QW

T **01467 620360** F 01467 622959 E sales@andersonsofinverurie.co.uk