

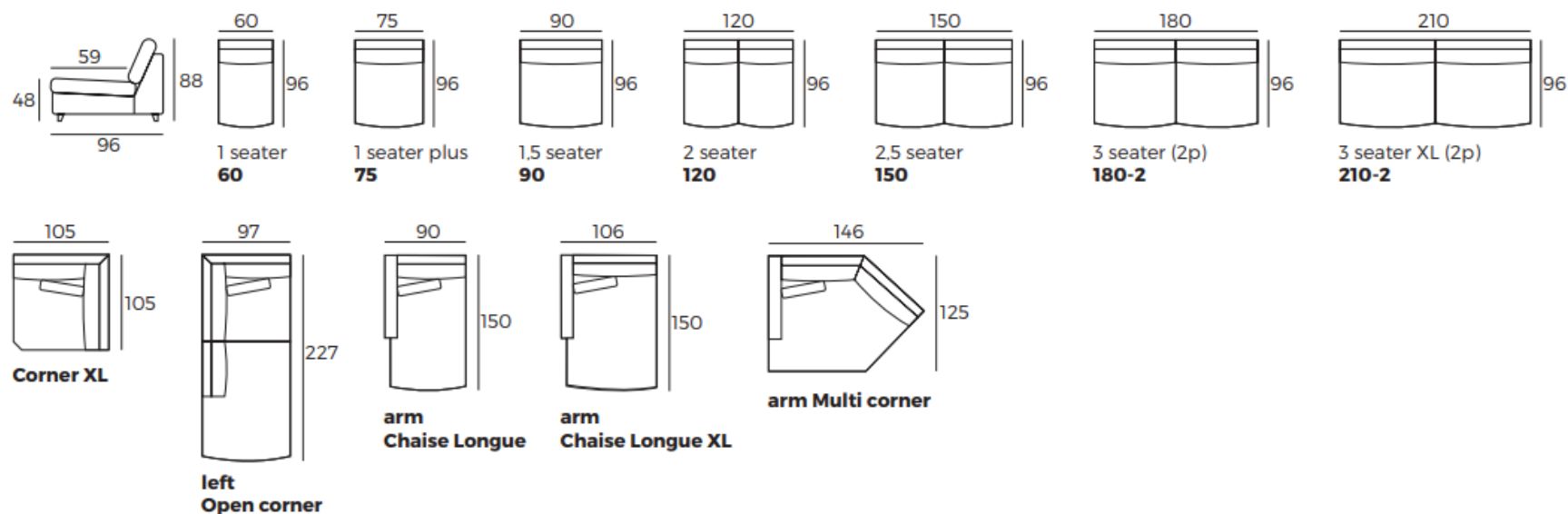

### 3. Legs



## Modules



## Modules with armrest

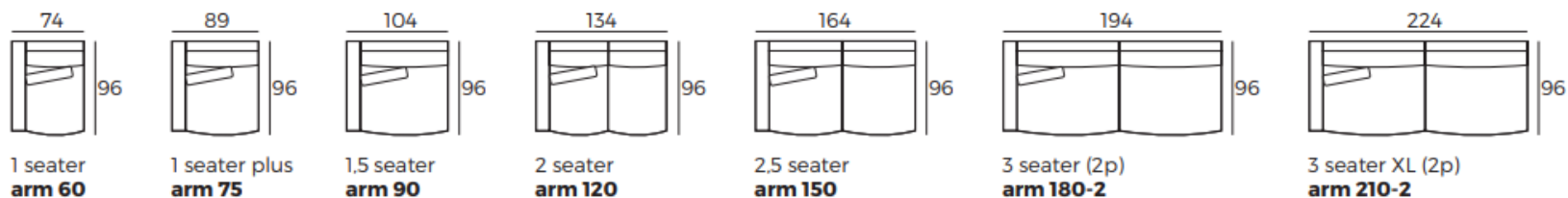



### 3. Legs



INVERURIE  
**Andersons**

# LINDEN

## Combinations

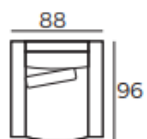

1 seater  
arm 60 arm

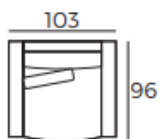

1 seater plus  
arm 75 arm

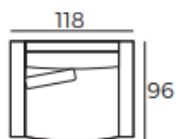

1,5 seater  
arm 90 arm

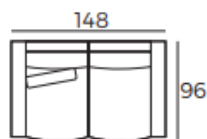

2 seater  
arm 120 arm

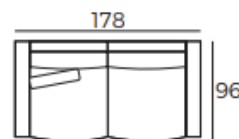

2,5 seater  
arm 150 arm

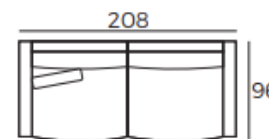

3 seater (2p)  
arm 180-2 arm

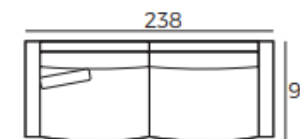

3 seater XL (2p)  
arm 210-2 arm

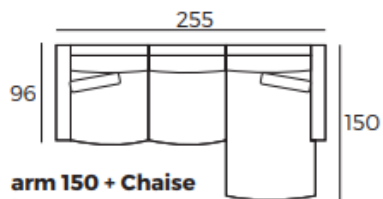

arm 150 + Chaise  
Longue arm

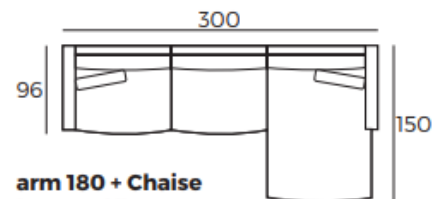

arm 180 + Chaise  
Longue XL arm

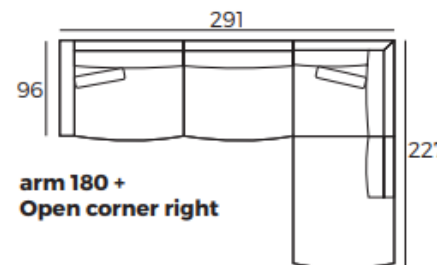

arm 180 +  
Open corner right

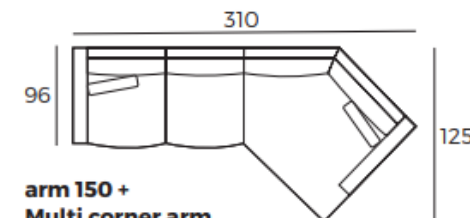

arm 150 +  
Multi corner arm

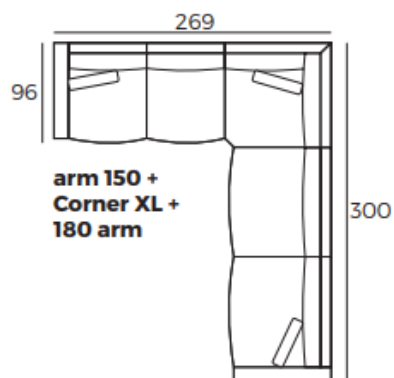

arm 150 +  
Corner XL +  
180 arm

## Accessories

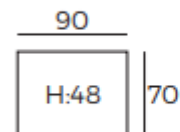

Footstool  
90x70